

Cub Cadet

**PREMIUM.
POWERFUL.
PERFORMANCE.**



2023 CUB CADET CATALOGUE

Cub Cadet
Drive it...we DARE you!

WE SAY DRIVE IT...WE DARE YOU BECAUSE WE KNOW YOU WILL LOVE THE POWER, CONTROL AND PRECISION ONLY A CUB CAN DELIVER.

Cub Cadet equipment delivers the ultimate in productivity through a combination of sustained power, detailed precision and control. Innovation drives the design, engineering and function of every Cub Cadet and we've been backing this up for decades by building products that work hard at maintaining your lawn and garden.

We pride ourselves on providing you, the customer, with quality products that are comfortable to use and exceed your expectations.

Want to experience the power, precision and control for yourself? Book a test drive with your local Cub Cadet Dealer today.

Drive it...we DARE you!

TABLE OF CONTENTS

XT Enduro Series™ Advantages	4-5
XT1 Enduro Series™	6-7
XT2 Enduro Series™	8-9
Ultima Series™ Advantages	10-11
Ultima Series™ ZT1 & ZT2	12-13
Ultima Series™ ZTS	14-15
Ultima Series™ ZTX5	16-17
Z-FORCE® SX Series	18-19
Wheeled String Trimmer	20-21
Electric Ride On Mowers	22-23
Commercial PRO Series	24-25
PRO Z 100 S Series	26-27
PRO Z 500 S Series	28-29
PRO Z 700 S Series	30-31
PRO Z 900 S Series	32-33
PRO Z 900 SD Series	34-35
PRO Z 900 SDL Series	36-37
HW PRO Series & PRO X Series	38-39
Full Specifications	40-47

SEE IT
IN ACTION.

Visit www.cubcadet.com.au on your mobile device.
Product Details | Videos | Locate a Cub Cadet Dealer

STRENGTH BUILT INTO EVERY DETAIL.

From the moment you buy to the moment you mow, Cub Cadet is fully committed to giving you the unrivaled experience that comes with the XT Enduro Series™. Take a look at all of the XT Enduro advantages tailored to help you create your best lawn yet.



XT1
ENDURO SERIES™



XT2
ENDURO SERIES™

XT ENDURO SERIES ADVANTAGES

- ▶ **AeroForce™ Fabricated Decks Deliver a Best-in-Class Cut**
A heavy-duty fabricated AeroForce™ deck cutting system has been rigorously tested to deliver a precise cut, with optimised airflow and maximised suction that eliminates clumping during discharge and improves bagging performance (XT2 models only).
- ▶ **Incredibly Responsive Handling**
Automotive-inspired handling with an optimised steering system that delivers a one-touch, 16-inch turning radius on the XT1 and XT2.
- ▶ **Standard in Comfort**
Adjustable high-back seats across the range and armrests available on the XT2 models, refined ergonomics and bold styling.
- ▶ **Smooth and Simple Operation**
Hydrostatic transmission—no shifting, just push the pedal and go.
- ▶ **Unmatched Support in the Industry**
An experienced national dealer network delivers dedicated personal owner support seven days a week.
- ▶ **Strong Warranty**
 - 6-year domestic & 90 day commercial unit warranty
 - 6-year domestic & 90 day commercial engine warranty
- ▶ **Year-Round Attachments**
Bagging and mulching attachments maximise the versatility of your Cub Cadet lawn tractor.

A CUT ABOVE.

The next generation of ride on mowers is here. The XT1 Enduro Series™ is the industry benchmark with power, comfort, precision and control for the ultimate mowing experience. Loaded with features, The XT1 Enduro Series™ is ideally equipped for easy mowing and hauling around the yard.

▶ Power On A Whole New Level

The XT1 LT 42 features a 547cc Cub Cadet single OHV engine with IntelliPower™ technology that provides more available power under wet, heavy loads resulting in less bogging down and more consistent cutting.

▶ Advanced Cutting Performance

A muscular cutting system featuring a 107cm (42") stamped deck built with heavy-duty material and an advanced belt design ensures durability and reliability while delivering the pristine Cub Cadet Signature Cut™.

▶ Incredibly Responsive Handling

With a tight 16" turning circle that enables you to manoeuvre around obstacles on your lawn, the XT1's steering system delivers optimised command and control at every turn.

▶ Added Comfort

High-back seats, comfort-grip steering and overall ergonomics are designed to keep you comfortable for extended periods.

XT1

ENDURO SERIES™

• XT1 LT 42 IntelliPower™

(See page 40 for full specifications)



INTELLIPOWER™
OPTIMISED ENGINE TECHNOLOGY



WARRANTY

6-year unit domestic warranty. 90 day unit commercial warranty.
6-year engine domestic warranty. 90 day engine commercial warranty.



AS PREMIUM AS PREMIUM GETS.

The XT2 Enduro Series delivers even higher levels of power, control and durability - all with a premium automotive-inspired design.

The XT2 LX 42 and LX 46 EFI models deliver smart tech features such as Electronic Fuel Injection and push button start. The LX 42 Kawasaki® model's 24HP engine gives you the power to take on larger areas with ease.

Stronger Engine Choices

The LX 42 & LX 46 EFI models feature a 679cc Cub Cadet Electronic Fuel Injected engine that helps reduce maintenance. The EFI engine also offers Push Button Start (PBS) giving you keyless starts – just push a button and go. The LX 42 Kawasaki® model features a powerful 24HP engine ideal for larger, more challenging areas.

Comfort With Added Extras

High-back seats with armrests ensure you stay comfortable for extended periods, along with a standard front bumper, cruise control plus LED headlights for maximum visibility.

Auto Traction Control

Automatic locking rear differential for all weather conditions and cutting terrains available on both the XT2 LX 42 EFI and the XT2 LX 46 models.



WARRANTY

6-year unit domestic warranty. 90 day unit commercial warranty.
6-year engine domestic warranty. 90 day engine commercial warranty.

XT2 ENDURO SERIES™

- XT2 LX 42 (EFI), XT2 LX 42 (KAWASAKI®) & XT2 LX 46

(See page 40 for full specifications)



- XT2 LX 42
Kawasaki
ENGINES



- XT2 LX 42
EFI



- XT2 LX 46



ULTIMA SERIES

THE ULTIMATE ALL-AROUND MOWING EXPERIENCE.

STEERING OPTIONS TO MEET YOUR NEEDS



Lap Bars

Overmolded and fully adjustable rubber hand grips generate less vibration for added comfort.



Steering Wheel

Professional-grade Synchro-Steer™ technology, exclusive to Cub Cadet, makes for a familiar user experience as well as enhanced precision, control and stability on hills up to 20 degrees.

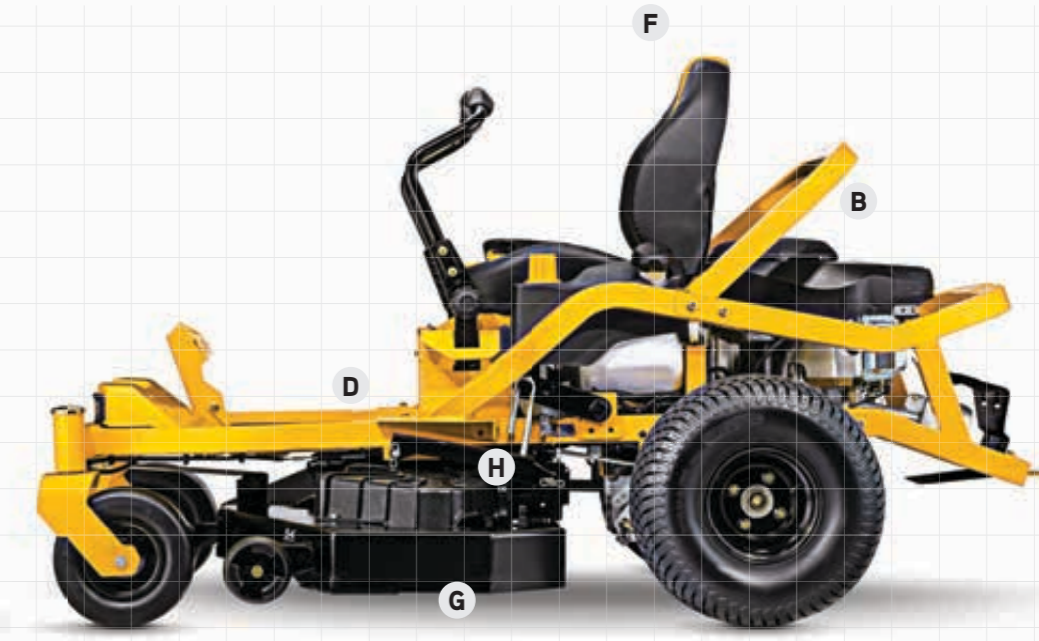
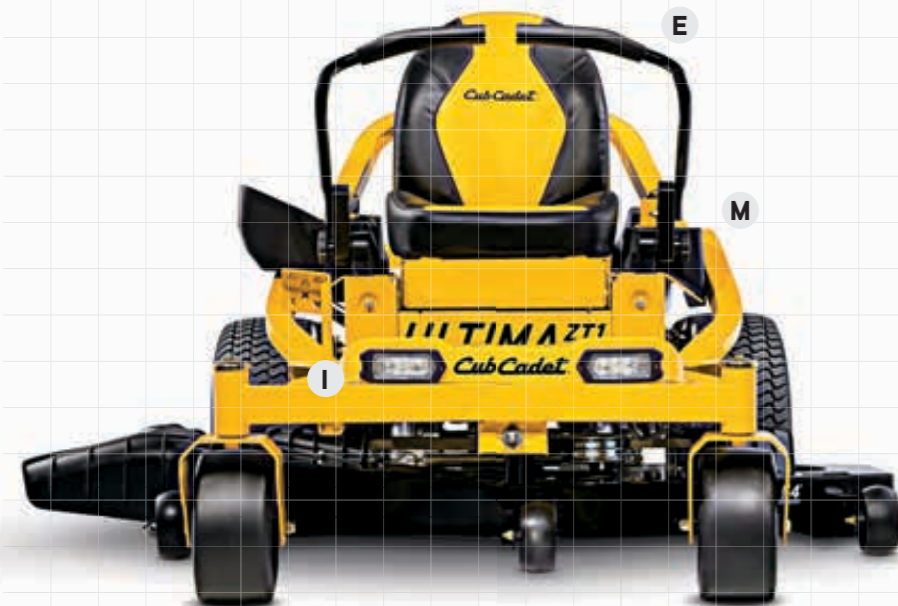

Forged for Enhanced Strength and Durability

- A:** Continuous tubular steel frame
- B:** Premium Kawasaki® engines (ZT1, ZT2 & ZTX models only)

Redefined Comfort for Maximum Speed

- C:** Durable, advanced polymer seat suspension
- D:** Rubber floor mat and ample legroom
- E:** Overmolded rubber hand grips or intuitive Soft-Touch steering wheel with adjustable steering column
- F:** Automotive-inspired, ergonomic, fully adjustable high-back seat

Cut Quality for the Perfect Pass

- G:** Stamped and fully welded fabricated steel AeroForce™ deck options
- H:** 15 quarter-inch deck height adjustments

- I:** Offset front axle on all lap bar units for precise trimming
- J:** Premium Turf Master rear tyres

Maintain With Ease

- K:** Maintenance-free spindles
- L:** Hinged floor pan for maintenance needs
- M:** Strong warranty, including the fabricated deck shells

THE ZERO-TURN LEADER.

Step up to the ultimate all-around mowing experience with unrivalled strength, comfort and performance. The best-in-class cut on the Ultima Series™ ZT will bring you one step closer to your best lawn yet.

► Tough Build

A continuous 5cm x 5cm tubular steel frame with protective e-coat on its lower end gives you optimal durability and strength with automotive-grade corrosion resistance for long-lasting use.

► Redefined Comfort

An automotive-inspired, fully adjustable 51cm high-back seat (armrests available on the ZT2 54), ergonomic hand grips and a rubber floor mat let you comfortably cut at a maximum forward speed of up to 11km/h.

► Best-In-Class Cutting Performance

Independently tested and proven, the fabricated decks on the ZT1 46 and ZT2 54, in combination with 15-position deck height adjustment options and an offset front axle, deliver a best-in-class cut with fewer clumps, finer clippings and increased evenness.

► Seamless Maintenance

Highly accessible hinged floor pan for easy deck access and maintenance-free spindles make routine servicing quick and simple.



WARRANTY

3-year unit domestic warranty. 90 day unit commercial warranty.
3-year engine domestic warranty. 90 day engine commercial warranty.
5-year fabricated deck shell domestic warranty.

ULTIMA SERIES

THE ULTIMA SERIES™ ZT1 & ZT2

- ZT1 42, ZT1 46 & ZT2 54

(See page 41 for full specifications)



• ZT1 46



• ZT1 42



• ZT2 54

Kawasaki
— ENGINES —



STEER IT TO BELIEVE IT.

The Ultima ZTS brings Cub Cadet's innovative and proprietary Synchro-Steer™ technology to the proven Ultima Series™ platform for enhanced precision and confident control on challenging hills—all backed by the superior strength, comfort and cut quality of Cub Cadet.

- Effortless Control**
 Step up your control from traditional lap bars with Synchro-Steer™ technology. The familiar steering wheel experience plus four-wheel control makes for enhanced precision, manoeuvrability and stability on all terrain—including hills of up to 20 degrees.
- Tougher Than Tough**
 A continuous 5cm x 5cm tubular steel frame with protective e-coat on its lower end gives you optimal durability and strength with automotive-grade corrosion resistance for long-lasting use giving you added peace of mind.
- Best-In-Class Cutting Performance**
 Independently tested and proven, the fabricated decks, in combination with 15-position deck height adjustment options and an offset front axle, deliver a best-in-class cut with fewer clumps, finer clippings and increased evenness.
- First-Class Comfort**
 An automotive-inspired, fully adjustable 51cm high-back seat and armrests, a soft-touch steering wheel with adjustable steering column, and a rubber floor mat let you comfortably cut at your maximum speed for all day mowing.



WARRANTY

3-year unit domestic warranty. 90 day unit commercial warranty.
 3-year engine domestic warranty. 90 day engine commercial warranty.
 5-year fabricated deck shell domestic warranty.

ULTIMA SERIES

THE ULTIMA SERIES™ ZTS1

NEW

- ZTS1 42 & ZTS1 46

(See page 41 for full specifications)



Synchro-Steer™ technology



• ZTS1 42



• ZTS1 46



Overseas model shown. Australian model features armrests.

STEP UP TO ANY CHALLENGE.

The professional-grade build of the Ultima Series™ ZTX zero turns deliver enhanced strength and durability so you can comfortably cut at maximum speed through the most challenging conditions.

- Strength On Deck**
 Built on a 4cm x 8cm tubular frame and featuring a 10-gauge steel fabricated AeroForce Max™ deck with side, top and leading-edge reinforcements and best-in-class bagging capabilities, you will be equipped with the right amount of strength and rigidity for consistent productive mowing.
- Built-In Longevity**
 The professional-grade Kawasaki® engines are backed by a strong 3-year domestic warranty and service support from our extensive dealer network nationwide to assure the extended lifetime of your machine.
- Command With Comfort**
 Advanced polymer seat isolators, isolated front caster suspension and an automotive class 51cm high-back seat with padded armrests deliver a smooth, quiet ride at up to 14km/h with less vibration than other zero turns.
- Endless Versatility**
 With a full line-up of premium attachments and LED headlights, as well as a standard rollover protection system (ROPS) plus rear tow hitch, build the perfect zero turn package to tackle all of your needs.



WARRANTY

3-year unit domestic warranty. 2-year unit commercial warranty.
 3-year engine domestic warranty. 2-year engine commercial warranty.
 5-year fabricated deck shell domestic warranty.

ULTIMA SERIES™ THE ULTIMA SERIES™ ZTX5

- ZTX5 48, ZTX5 54 & ZTX5 60

(See page 42 for full specifications)



• ZTX5 48



• ZTX5 54



• ZTX5 60



HEAVY DUTY. EASY RIDE.

Feature packed for premium performance, the Z-FORCE® SX Series gives you more. You will not only become confident with the Synchro-Steer™ four-wheel, car-like steering wheel control, but also an impressive list of professional-feature upgrades. More comfort. More power. More precision. More durability. More reasons you'll look forward to a satisfying day caring for your property.

Advanced Manoeuvrability And Confidence

With the ease of steering-wheel control and stability of four-wheel steering, you'll have unprecedented command over challenging areas including hills of up to 20° slopes and uneven terrain.

Incredible Strength

Powerful Kawasaki® engines, fully welded full-length steel frames and tough fabricated decks with heavy-duty spindles deliver outstanding results year after year.

Amazing Comfort

From the moment you sit on the comfortable high-back seat, you'll know you're in for a great ride. Standard armrests, adjustable steering column, a roomy footrest and the easy-lift deck height adjuster are just a few of the features that make this rider great for all-day operation.



WARRANTY

3-year unit domestic warranty. 1-year unit commercial warranty.
3-year engine domestic warranty. 1-year engine commercial warranty.
5-year fabricated deck shell domestic warranty.

Z-FORCE
ZERO-TURN RIDER

• Z-FORCE® SX 48 & Z-FORCE® SX 54

(See page 43 for full specifications)

Kawasaki
ENGINES



Synchro-Steer™ technology



• Z-FORCE® SX 48



• Z-FORCE® SX 54



THE POWER TO CUT IT ALL.

The Cub Cadet wheeled string trimmer has the power to clear tall and thick grasses, heavy brush as well as other vegetation making it ideal for larger, tougher jobs. The offset deck means the trimmer can be used against walls and fence lines while walking in a straight line. Easy to use and manoeuvre, the trimmer cuts through difficult areas with ease putting you in control.

Simple Height Adjustment

Easily change the multi-position cutting height. Lower for trimming along fences, retaining walls and structures; higher for long, thick weeds in a field.

Exceptional Handling

The ball-bearing wheels give remarkable manoeuvrability on uneven terrain. The offset head design easily cuts around obstacles like fence lines and corners.

Powerful Performance

With a powerful Cub Cadet 140cc engine, tackle the tough stuff without worrying about bogging down.

WHEELED STRING TRIMMER	
ENGINE	
Engine Type	140cc Cub Cadet engine, 4-stroke
CUTTING	
Cutting Width / Height	56cm (22") / adjustable, 4.1cm (1.6") - 7.6cm (3")
WHEELS	
Wheel Type	35.6cm (14") ball bearing wheels
HANDLE	
Handle Type	Adjustable, 3-position loop
WARRANTY*	
Warranty	Unit: 2-year domestic and 90 day commercial / Engine: 2-year domestic and 90 day commercial

WHEELED STRING TRIMMER



BATTERY POWERED. EMPHASIS ON POWER.

Your lawn care depends on strong equipment, and our electric lineup won't let you down. Each piece is engineered with the same uncompromising commitment to design, comfort and performance we demand from every product.



• XT1 LT42 E



• CC30 E



ELECTRIC RIDE ON MOWERS

• CC30 E & XT1 LT42 E

(See page 44 for full specifications)

CC30 E Compact Ride On Mower

- ▶ Compact size gives incredible manoeuvrability and control so you can mow where nothing else can.
- ▶ 56V Max 1,500Wh-30Ah Lithium Ion battery and run times of up to 6km/h and up to 1 acre per full charge.
- ▶ Packed with user-friendly features like a high-back seat, soft-touch steering wheel, front bumper, LED lights and cruise control.
- ▶ Direct-drive 76cm (30") stamped deck powered by one brushless motor allows for optimal airflow and efficiency, along with side-discharge, bagging and mulching capabilities to deliver a consistent premium cut with every mow.

XT1™ ENDURO SERIES™

XT1 LT 42 E Ride On Mower

- ▶ Automatic transmission requires no shifting—just push the pedal and go.
- ▶ 56V Max 3,000Wh-60Ah Lithium Ion battery and run times of up to 1.5 acres per full charge.
- ▶ Loaded with modern comforts like automotive-inspired steering, adjustable seating and cruise control.
- ▶ Direct-drive 107cm (42") stamped deck powered by one brushless motor per blade allows for optimal airflow and efficiency, along with side-discharge, bagging and mulching capabilities to deliver a consistent premium cut with every mow.



FLEXIBLE CHARGING SYSTEM.

Get a lightning-fast charge from a standard 110V outlet without waiting overnight. In a pinch, charge to the exact power you need without risking battery damage.



100% EMISSION-FREE EQUIPMENT WHEN MOWING.

No exhaust, carbon monoxide or unburned hydrocarbons from the on-board power source for cleaner operation.



NO PETROL. NO OIL. NO HASSLES.

Less time getting ready to cut means more time enjoying your yard.



SIGNIFICANTLY QUIETER THAN GAS.

Cut at dawn or dusk without disturbing the neighborhood.



WARRANTY

6-year unit domestic warranty. 90-day unit commercial warranty.
6-year engine domestic warranty. 90-day engine commercial warranty.

ELECTRIC
LITHIUM ION



BUILT FOR BUSINESS.



Make your business mean business.

We asked commercial users what they expect and demand from their equipment and then started from scratch.

Designing every element of our commercial offering with the professional in mind, we put them through rigorous testing, not finalising our design until we addressed the common setbacks landscapers experience.

The result is a quality professional line-up that lets you take on long seasons of demanding work with confidence.

THE ULTIMATE MANOUEVRABILITY

UNRIVALLED STEERING WHEEL CONTROL

Steering wheel control increases productivity, mowing hillsides and terrains that lap bars can't handle.

- ▶ Reduces mowing time by up to 10% compared to lap bar models.
- ▶ Delivers true zero turn handling, less overlap and straighter lines.
- ▶ Four-wheel steering for unmatched hillside stability.

Unmatched hillside confidence

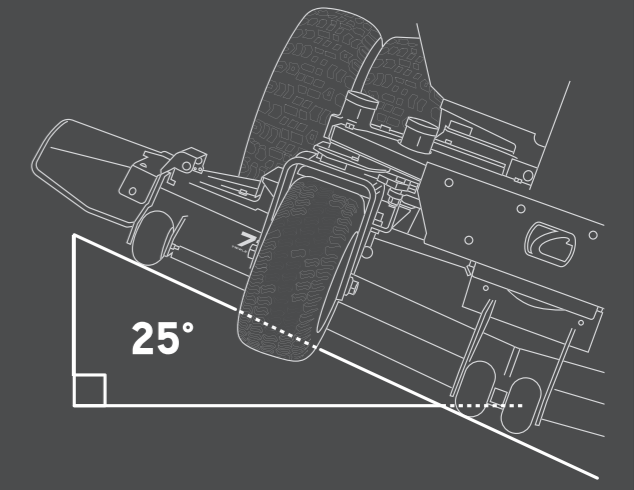

Available on the PRO Z 972 SD and 972 SDL.

STRONG RESULTS WITH STEERING CONTROL.

The PRO Z 100 S Series is built to stand strong with a fully reinforced frame, triple-guard fabricated decks and commercial electronic fuel-injected engines for amazing fuel efficiency. Add four-wheel steering that eliminates turf damage and gives unmatched hillside stability of up to 20° slopes, the PRO Z 100 S Series will give you the confidence that your equipment will work hard all day, every day.

► Power And Efficiency

High-performance, maximum-power Kohler® Confidant V-Twin EFI engines provide increased torque and give up to 25% in fuel savings when compared to an equivalent carburettor for the ultimate in efficiency. The heavy-duty air filter and filtration system ensures a longer engine life so that you'll be cutting with confidence year after year.

► Heavy-Duty Decks With A Professional Cut

Extra-tough fabricated decks for added durability that feature anti-scalping wheels at the front and side of the deck to give your lawn a professional looking cut.

► Amazing Comfort

From the moment you sit in the comfortable high-back seat, you'll know you're in for a great ride. Standard armrests, adjustable steering column and the easy-lift deck height adjuster are just a few of the features that make this rider great for all-day operation.

PRO Z 100 S SERIES

- PRO Z 148 S & PRO Z 154 S

(See page 45 for full specifications)

POWERED BY
KOHLER

PRO Z 148 S

- Engine HP: 25HP
- Transmission: Dual Hydro-Gear®
- Deck: 122cm (48")



PRO Z 154 S

- Engine HP: 27HP
- Transmission: Dual Hydro-Gear®
- Deck: 137cm (54")



WARRANTY

3-year unit domestic warranty. 2-year unit commercial warranty.
3-year engine domestic & commercial warranty.
5-year fabricated deck shell domestic warranty.

CUTTING EVERYTHING INCLUDING DOWNTIME.

With an incredible combination of strength and comfort features, the PRO Z 500 S Series is a force to be reckoned with. The steering wheel, with Cub Cadet's Synchro-Steer™ technology, helps eliminate turf damage and provides unmatched stability on up to 20°.

► Tough, Durable Deck

Stand up to the toughest conditions with the only commercial lawn mower touting a triple-7-gauge steel cutting deck complete with 7-gauge top and bottom reinforcements, plus ¼" leading edge and 5/16" side reinforcements. The extra-tough fabricated deck offers added durability that features anti-scalping wheels at the front and side of the deck to give your lawn a professional looking cut.

► Unbeatable Durability

The Cub Cadet Triple Guard Corrosion Defense System™ with e-coat delivers automotive-grade corrosion resistance against the elements and wear and tear.

► Amazing Comfort

From the moment you sit in the comfortable high-back seat, you'll know you're in for a great ride. Standard armrests, adjustable steering column, an easy-lift deck height adjuster and the ISO mounted foot base that reduces vibrations through the operator's feet, are just a few of the features that make this rider great for all-day operation.



WARRANTY

3-year unit domestic & commercial warranty.
3-year engine domestic & commercial warranty.
5-year fabricated deck shell domestic warranty.

PRO Z 500 S SERIES

- PRO Z 554 S & PRO Z 560 S

(See page 46 for full specifications)

Kawasaki
— ENGINES —

PRO Z 554 S

- Engine HP: 27HP
- Transmission: Parker®
- Deck: 137cm (54")



PRO Z 560 S

- Engine HP: 31HP
- Transmission: Parker®
- Deck: 152cm (60")



AN EASY DAY'S WORK WITH GREATER CONTROL.

The big challenges are no match for the advanced power of the PRO Z 700 S Series. Heavy-duty construction, faster mowing speeds and a larger deck option make this an essential step up for large crews working on extensive jobs. Add steering wheel control and amazing comfort, the PRO Z 700 S Series keeps you working efficiently all day.

► Tough, Durable Deck

Stand up to the toughest conditions with the only commercial lawn mower touting a triple-7-gauge steel cutting deck complete with 7-gauge top and bottom reinforcements, plus ¼" leading edge and 5/16" side reinforcements. The extra-tough fabricated deck offers added durability that features anti-scalping wheels at the front and side of the deck to give your lawn a professional looking cut.

► Unbeatable Durability

The Cub Cadet Triple Guard Corrosion Defense System™ with e-coat delivers automotive-grade corrosion resistance against the elements and wear and tear.

► The Ultimate In Comfort

From the moment you sit in the comfortable high-back seat, you'll know you're in for a great ride. Padded armrests, adjustable steering column, an easy-lift deck height adjuster and the ISO mounted foot base that reduces vibrations through the operator's feet are just a few of the features that make this rider great for all-day operation.

PRO Z 700 S SERIES

• PRO Z 760 S

(See page 46 for full specifications)

Kawasaki
— ENGINES —



PRO Z 760 S

- Engine HP: 31HP
- Transmission: Parker®
- Deck: 152cm (60")



WARRANTY

3-year unit domestic & commercial warranty.
3-year engine domestic & commercial warranty.
5-year fabricated deck shell domestic warranty.

HEAVY-DUTY STRENGTH AND DURABILITY

Combining incredible strength with amazing all-day comfort, the PRO Z 972 S is tough to beat. The biggest challenges are no match for the advanced power of the Kawasaki® engine and strength of the triple-7-gauge deck. Heavy-duty construction, faster mowing speeds, our largest deck yet and superior comfort all make the PRO Z 972 S the ideal zero turn for large crews working on the toughest, most extensive jobs.

► Tough, Durable Deck

Stand up to the toughest conditions with the only commercial lawn mower touting a triple-7-gauge steel cutting deck complete with 7-gauge top and bottom reinforcements, plus ¼" leading edge and 5/16" side reinforcements. The extra-tough fabricated deck offers added durability that features anti-scalping wheels at the front and side of the deck to give your lawn a professional looking cut.

► Unbeatable Durability

The Cub Cadet Triple Guard Corrosion Defense System™ with e-coat delivers automotive-grade corrosion resistance against the elements and wear and tear.

► Work Hard, Ride Easy

Experience a smooth ride all day long with PRO Z comfort features. Our exclusive Air-Ride seat allows riders to adjust seat firmness to their personal preference. The isolation dampening system under the seat reduces vibration, while angle adjustment and lumbar support provide a customised mowing experience.



WARRANTY

3-year unit domestic & commercial warranty.
3-year engine domestic & commercial warranty.
5-year fabricated deck shell domestic warranty.

PRO Z 900 S SERIES

• PRO Z 972 S

(See page 47 for full specifications)

Kawasaki
— ENGINES —



PRO Z 972 S

- Engine HP: 35HP
- Transmission: Parker®
- Deck: 183cm (72")



STRENGTH, DURABILITY AND KING OF THE HILLS

When it comes to the PRO Z 972 SD, you won't be disappointed in the unmatched durability, stability and performance. Engineered with a first-of-its-kind drive system that includes four-wheel steering, as well as dual rear wheels for the ultimate in traction, the 972 SD cuts comfortably on steep 25° terrain. With superior comfort for all day mowing and the heavy-duty construction of the PRO Z 900 Series, the 972 SD is the ultimate mowing solution for landscapers and commercial users.

► Dominate Steep Hills

Oversized dual rear wheels give greater stability and precision. Four-wheel steering allows you to comfortably mow a straight line, execute zero-degree turns and operate on a hillside up to a 25° slope.

► Time Saving Electric Deck Lift

The easy to operate, single switch electronic powered deck lift requires less effort to lift or adjust the deck than standard foot operated deck lifts saving you time and energy.

► Work Hard, Ride Easy

Experience a smooth ride with PRO Z comfort features. Our exclusive Air-Ride seat allows riders to adjust seat firmness to their personal preference. The isolation dampening system under the seat reduces vibration, while angle adjustment and lumbar support give a custom feel.



WARRANTY

- 3-year unit domestic & commercial warranty.
- 3-year engine domestic & commercial warranty.
- 5-year fabricated deck shell domestic warranty.

PRO Z 900 SD SERIES

• PRO Z 972 SD

(See page 47 for full specifications)

Kawasaki
— ENGINES —

PRO Z 972 SD

- Engine HP: 35HP
- Transmission: Parker®
- Deck: 183cm (72")



Dual rear wheels

Oversized dual rear wheels provide a high level of stability, traction and precision on the PRO Z 972 SD and SDL.



30 DEGREES OF COMFORT

The PRO Z 972 SDL is a dual-wheel commercial zero-turn engineered to dominate steep hills with up to a 25° slope or 46% of grade. With its unmatched maintenance-free deck, superior cutting performance and self-levelling Air-Ride comfort seat, this best-in-class mower is the ultimate mowing solution for municipalities, commercial operators and large properties with varying terrain.

Dominate Steep Hills

Oversized dual rear wheels give greater stability and precision. Four-wheel steering allows you to comfortably mow a straight line, execute zero-degree turns operate on a hillside up to a 25° slope.

Time Saving Electric Deck Lift

The easy to operate, single switch electronic powered deck lift requires less effort to lift or adjust the deck than standard foot operated deck lifts saving you time and energy.

Maximised Comfort

Experience a smoother ride with the self-levelling Air-Ride seat that lets you operate with up to 15° of self-levelling side-to-side as well as the ability to adjust seat firmness to your personal preference for the ultimate in stability and comfort. The isolation dampening system under the seat reduces vibration, while angle adjustment and lumbar support provide a custom mowing experience.



WARRANTY

3-year unit domestic & commercial warranty.
3-year engine domestic & commercial warranty.
5-year fabricated deck shell domestic warranty.

PRO Z 900 SDL SERIES

PRO Z 972 SDL

(See page 47 for full specifications)

Kawasaki
— ENGINES —

PRO Z 972 SDL

- Engine HP: 35HP
- Transmission: Parker®
- Deck: 183cm (72")



Maximized comfort

The self-leveling air-ride seat on the PRO Z 972 SDL lets you operate with up to 15 degrees of self-leveling from side to side.

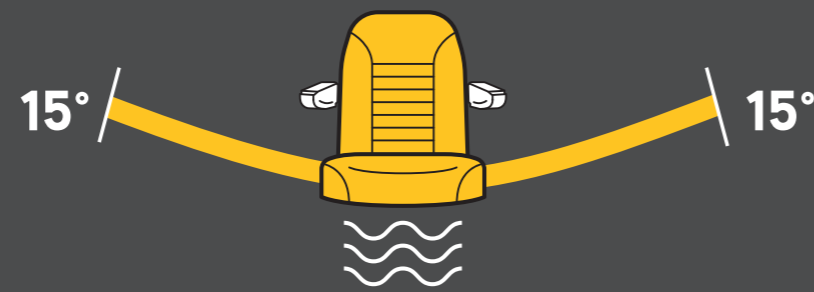



HW PRO SERIES

Kawasaki
— ENGINES —

(See page 43 for full specifications)

UNBEATABLE IN EVERY ENVIRONMENT

Cub Cadet's professional hydrostatic drive walk behind mower, the PRO HW Series, is built for maximum performance and minimal downtime. With innovative steering technology, durable deck and rugged construction, this professional walk behind is tough enough to tackle difficult terrain in every environment.

- **Unmatched Steering**
Optimal weight distribution and large tyres maximise stability on hillsides and slopes, while hand-lever steering control uses less force to steer the mower meaning less fatigue.
- **Easy Control**
Straight-line adjustable tracking allows for on the go straight line adjustments with the turn of a knob and cruise control gives ultimate speed control so you can mow at your own pace.
- **Durability At Its Core**
The 10-gauge steel deck shell with 7-gauge top and bottom reinforcements ensure that this cutting deck can take a beating. A 7-gauge leading edge and 1/4" side reinforcements add to the all-round heavy-duty construction. Maintenance-free sealed spindles maximise performance and reduce downtime.

PRO X SERIES

Kawasaki
— ENGINES —

- PRO X 648
(See page 43 for full specifications)

STRENGTH TAKES A STAND

Seize productivity with the latest addition to the Cub Cadet professional line up. The PRO X 648 gives you the zero turn flexibility you need to mow a wider range of properties. The easy-to-adjust suspension platform accommodates any operator while the smooth and highly responsive controls allow for less vibration and peak manoeuvrability, maximising your productivity and comfort.

- **Unmatched Ground Clearance**
With a fully fabricated 10-gauge deck shell, 7-gauge top and bottom reinforcements, plus standard 61cm tyres, the PRO X 648 gives you more ground clearance to easily hop on curbs.
- **Greater Impact Absorption**
A large, fully adjustable suspension platform allows you to fine-tune tension and glide comfortably over the roughest of terrains.
- **Optimised Performance**
An easy step-on/step-off design allows for quick debris pickup while the bigger 122cm (48") fabricated steel deck maxes out traction and reduces turfing for an even, professional cut.



WARRANTY
3-year unit domestic & commercial warranty.
3-year engine domestic & commercial warranty.
5-year fabricated deck shell domestic warranty.

ENDURO SERIES

SELECTION GUIDE	XT1 LT 42	XT2 LX 42 (KAWASAKI)	XT2 LX 42 (EFI)	XT2 LX 46
ENGINE				
Engine Type	547cc Cub Cadet Single OHV w/IntelliPower™	24HP Kawasaki® V-Twin OHV	679cc Cub Cadet V-Twin OHV, EFI	
Fuel Tank Capacity	11.4 litres		9.5 litres	
DRIVE SYSTEM				
Transmission	Hydro, Foot (Tuff Torq)		Auto-Diff Hydro, Foot (Tuff Torq)	
Cruise Control	Standard			
CONTROLS				
Steering Control	Standard steering wheel			
Start Type	Key		Push Button Start (PBS)	
Mow In Reverse	Standard			
CUTTING DECK				
Cutting Width	107cm (42"), pressed steel	107cm (42"), fabricated steel		117cm (46"), fabricated steel
Height Adjustment	12-positions / 2.5cm - 10cm (1" - 4")			
Deck Blade Engagement	Manual, lever	Electronic fingertip engagement allows you to easily engage and disengage the mowing deck saving you time and energy		
Deck Wash	Patented SmartJet™ high-pressure deck washing system			
CHASSIS				
Frame	Fully robotically welded frame			
Front / Rear Tyres	15.00 x 6.00 (Turf Saver) / 20.00 x 8.00 (Turf Saver)	15.00 x 6.00 (Multi-Trac) / 20.00 x 8.00 (Multi-Trac)		
COMFORT				
Seat	High-back	High-back with armrests		
ADDITIONAL FEATURES				
Additional Features	Turning radius 41cm (16")			
WARRANTY				
Warranty	Unit: 6-year domestic and 90 day commercial / Engine: 6-year domestic and 90 day commercial			



ACCESSORIES

				
Mulch Kit 42" Deck Fits XT1 LT 42, XT2 LX 42/46 # 19A70041100	Mulch Kit 46" Fab Deck Fits XT2 LX46 # 19B30005100	Double Bagger Catcher Fits XT1 LT 42 & XT2 LX 42/46 # 19A300310EM	4 Litre 4-Stroke Oil 10W30 # 333-000-0004	20 Litre 4-Stroke Oil 10W30 # 330-000-0010

ULTIMA SERIES





SELECTION GUIDE	ZT1 42	ZT1 46	ZT2 54	ZTS1 42	ZTS1 46
ENGINE					
Engine Type	21.5HP Kawasaki® V-Twin OHV	23HP Kawasaki® V-Twin OHV		679cc Cub Cadet V-Twin OHV	
Fuel Tank Capacity	13.2 litres, centre mounted				
DRIVE SYSTEM					
Transmission	Dual Hydro-Gear® EZT-2200		Dual Hydro-Gear® ZT-2800	Dual Hydro-Gear® EZT-2200	
Forward / Reverse Speeds	Up to 11km/h / 6km/h				
CONTROLS					
Steering Control	Over-molded soft-touch ergo grip lap bars with integrated parking brake system			Steering wheel with Synchro-Steer™ technology	
CUTTING DECK					
Deck Construction	13-gauge pressed steel deck	11-gauge AeroForce™ fabricated deck	11-gauge flat top fabricated deck	11-gauge AeroForce™ fabricated deck	
Cutting Width / Blades	107cm (42") / twin blade	117cm (46") / twin blade	137cm (54") / triple blade	107cm (42") / twin blade	117cm (46") / twin blade
Deck Blade Engagement	Electronic fingertip engagement				
Deck Lift / Height	Foot-operated / 15-position / dial adjust / 2.5cm - 11.4cm (1" - 4.5")				
CHASSIS					
Frame / Front Castor Mounts	Square 5cm x 5cm (2" x 2") tubular upper and lower frame structure / Rectangular 5cm x 6cm (2" x 2.5") square frame / offset				
ROPS	N/A				
Front / Rear Tyres	11.00 x 6.00 (smooth) / 20.00 x 8.00 (Turf Master)		13.00 x 6.50 (smooth) / 20.00 x 12.00 (Turf Master)	13.00 x 6.50 (Turf Master) / 20.00 x 8.00 (Turf Master)	
COMFORT					
Seat	Premium high-back adjustable seat		Premium high-back adjustable seat with cushioned armrests & ball-bearing seat slide		
Floor Mat	Rubber				
ADDITIONAL FEATURES					
Additional Features	Dual LED headlights, multi-tool and removable floor pan				
WARRANTY*					
Warranty	Unit: 3-year domestic and 90 day commercial / Engine: 3-year domestic and 90 day commercial. 5-year fabricated deck shell.				

ACCESSORIES

							
Mulch Kit 42" Deck Fits ZT1 42 # 19B70041100	Mulch Kit 46" Fab Deck Fits ZT1 46 & ZTS1 46 # 19A30047100	Mulch Kit 42" Fab Deck Fits ZTS1 42 # 19A30054100	Mulch Kit 54" Fab Deck Fits ZT2 54 # 19A30051100	Double Bagger Catcher Fits ZT1 42/46 & ZTS1 42/46 # 19B70054100	ZTS1 42/46 Bagger Mounting Kit Required to mount catcher # 490-950-C062	Triple Bagger Catcher Fits ZT2 54 # 19A70056100	Lawn Striping Kit for 42", 50" & 54" decks # 19A700600EM



ULTIMA SERIES

SELECTION GUIDE	ZTX5 48	ZTX5 54	ZTX5 60
ENGINE			
Engine Type	23HP Kawasaki® V-Twin OHV		24HP Kawasaki® V-Twin OHV
Fuel Tank Capacity	Fuel Tank 20.8 litres, centre mounted		
DRIVE SYSTEM			
Transmission	Dual Hydro-Gear® ZT-3200		
Forward / Reverse Speeds	Up to 14km/h / 6km/h		
CONTROLS			
Steering Control	Over-molded soft-touch ergo grip lap bars with integrated parking brake system		
CUTTING DECK			
Deck Construction	10-gauge AeroForce Max™ fabricated deck with 2-gauge reinforcement and 7-gauge side wraps plus skid plate		
Cutting Width / Blades	122cm (48") / triple blade	137cm (54") / triple blade	152cm (60") / triple blade
Deck Blade Engagement	Electronic fingertip engagement		
Deck Lift / Height	Foot operated / 15-position / dial adjust / transport mode / 3.8cm - 11.4cm (1.5" - 4.5")		
CHASSIS			
Frame / Front Castor Mounts	Rectangular 4cm x 8cm (1.5" x 3") tubular upper and lower frame structure / Rectangular 4cm x 8cm tubular frame / offset / front caster suspension		
ROPS	Foldable, Roll Over Protection System designed to keep you safe when mowing on difficult terrain		
Front / Rear Tyres	13.00 x 6.50 (smooth) / 23.00 x 12.00 (Turf Master)		
COMFORT			
Seat	Premium automotive class high-back adjustable seat with cushioned armrests, ball-bearing seat slide and patented suspension system		
Floor Mat	Rubber		
ADDITIONAL FEATURES			
Additional Features	Dual LED headlights, multi-tool and removable floor pan		
WARRANTY			
Warranty	Unit: 3-year domestic and 2-year commercial / Engine: 3-year domestic and 2-year commercial. 5-year fabricated deck shell.		

ACCESSORIES				
				
Mulch Kit 48" Fab Deck Fits ZTX5 48 # 19A70064100	Mulch Kit 54" Fab Deck Fits ZTX5 54 # 19A70065100	Mulch Kit 60" Fab Deck Fits ZTX5 60 # 19B70066100	Triple Bagger Catcher Fits ZTX5 48 # 49A70001100	Triple Bagger Catcher Fits ZTX5 54/60 # 49A70002100

Z-FORCE® SX SERIES

SELECTION GUIDE	Z-FORCE® SX 48	Z-FORCE® SX 54
ENGINE		
Engine Type	24HP Kawasaki® V-Twin OHV	
Fuel Tank Capacity	Twin 10.6 litre fuel tanks and 21.2 litres total to keep you mowing longer	
DRIVE SYSTEM		
Transmission	Dual Hydro-Gear® ZT-3100	
Cruise Control	Standard, foot-operated	
CONTROLS		
Steering Control	Four-wheel steering with steering wheel control	
Mow In Reverse	Standard	
CUTTING DECK		
Deck Construction	11-gauge fabricated deck with 2-gauge reinforcement and 7-gauge top plate	
Cutting Width	122cm (48")	137cm (54")
Height Adjustment	15-position / 2.5cm - 12.7cm (1" - 5")	
Deck Blade Engagement	Electronic fingertip engagement allows you to easily engage and disengage the mowing deck	
CHASSIS		
Frame	Heavy-duty 12-gauge one-piece, full-length steel frame	
Front / Rear Tyres	Front: 13.00 x 6.50 / Rear: 22.00 x 9.50	
COMFORT		
Seat	High-back EVC seat with armrests for all day comfort	
ADDITIONAL FEATURES		
Additional Features	Rear bumper standard	
WARRANTY		
Warranty	Unit: 3-year domestic and 1-year commercial / Engine: 3-year domestic and 1-year commercial. 5-year fabricated deck shell	

ACCESSORIES		
		
Mulch Kit 48" Deck Fits: Z-FORCE® SX 48 # 19A70037100	Mulch Kit 54" Deck Fits Z-FORCE® SX 54 # 19A70038100	Triple Bagger Catcher 48" & 54" Decks Fits Z-FORCE® SX 48/54 # 19A70040100

HW PRO SERIES

SELECTION GUIDE	PRO HW 336
ENGINE	
Engine Type	Commercial-grade 14.5HP Kawasaki® engine (603cc)
CUTTING	
Cutting Width / Blades	91cm (36") 10-gauge steel fabricated deck with 7-gauge top and bottom reinforcements / 2 high-lift Marbain® blades
CONTROLS	
Operator Controls	Single-lever cruise control with single-knob straight line tracking adjustment
STEERING	
Steering	Hand-lever steering control with ball bearing linkage for a smooth feel
ACCESSORIES	
Sulky Attachment	Quick attach with quick release function for effortless self-propelled mowing.
WARRANTY*	
Warranty	Unit: 3-year domestic and 2-year commercial / Engine: 3-year domestic and 3-year commercial. 5-year fabricated deck shell.

PRO X SERIES

SELECTION GUIDE	PRO X 648
ENGINE	
Engine Type	22HP Kawasaki® FX691v V-Twin OHV
DRIVE SYSTEM	
Transmission	12cc Hydro-Gear® pumps / 240cc Parker wheel motors
CUTTING DECK	
Deck Construction	10-gauge shell with 7-gauge top and bottom reinforcements
Cutting Width / Height	122cm (48") fabricated steel deck / 3.8cm (1-1/2") - 12.7cm (5")
Deck Blade Engagement	Electronic with quick reset
CHASSIS	
Frame	5cm (2") x 7.6 (3") full-length tube frame
ADDITIONAL FEATURES	
Additional Features	Electric starter, hour meter, fuel gauge, key switch, throttle, choke, 3-position operator cushion with cargo pocket and hand lever adjust, 3-position spring suspension foot platform
Front / Rear Tyres	Front: 13.00 x 5.00 smooth, flat-free Rear: 24.00 x 9.50
WARRANTY	
Warranty	Unit: 3-year domestic and 3-year commercial / Engine: 3-year domestic and 3-year commercial. 5-year fabricated deck shell.

ELECTRIC RIDE ON MOWERS

SELECTION GUIDE	CC 30 E	Enduro Series XT1 LT42 E
POWER		
Power Source / Battery	56V MAX 1,500Wh-30Ah / Lithium-ion battery	56V MAX 3,000Wh-60Ah / Lithium-ion battery
Run Time	Up to 1 hour or 1 acre	Up to 1.5 hours or 1.5 acres
Charger	110V anytime fast charger (4 hours to full charge)	
DRIVE SYSTEM		
Transmission	Foot-controlled electric drive	
Forward / Reverse Speeds	Up to 6km/h / 3km/h	Up to 8.5km/h / 4.5km/h
CONTROLS		
Steering Control	Optimized steering system, sector and pinion	Optimized steering system, sector and pinion
Mow In Reverse	Standard	
Cruise Control	Soft-touch engagement	
CUTTING DECK		
Deck Construction	14-gauge stamped deck	13-gauge stamped deck
Cutting Width	76cm (30"), pressed steel	107cm (42"), pressed steel
Deck Blade Engagement	Manual, lever	Electronic fingertip engagement allows you to easily engage and disengage the mowing deck saving you time and energy
Deck Lift	Lever / 5 positions / spring-assisted	Lever / 12 positions / spring-assisted
CHASSIS		
Frame	14-gauge welded steel	Fully robotically welded frame
Front / Rear Tyres	13.00 x 5.00 (Turf Saver) / 16.00 x 6.50 (Turf Saver)	15.00 x 6.00 (Turf Saver) / 20.00 x 8.00 (Turf Saver)
COMFORT		
Seat	15" Cub Comfort™ high-back seat / knob adjust	15" Cub Comfort™ deluxe high-back seat / 10 seat slide
ADDITIONAL FEATURES		
Additional Features	Cup holder, dual LED headlights, USB port & front bumper	Cup holder, dual LED headlights, USB port & front bumper
WARRANTY		
Warranty	Unit: 6-year domestic and 90 day commercial / Engine: 6-year domestic and 90 day commercial	





ACCESSORIES

							
Arm Rest Kit Fits all electric models # 757-06093	Mulch Kit - 30" Deck Fits CC 30 E # 19A300130EM	Catcher 30" Deck Fits CC 30 E # 19A300140EM	Mulch Kit 42" Deck Fits XT1 LT42 E # 19A30055100	Double Bagger Catcher Fits XT1 LT42 E # 19A30031100	Fast Attach Cargo Carrier Fits XT1 LT42 E # 19B30029100	FastAttach Brush Guard Fits XT1 LT42 E # 19A30038100	FastAttach Sun Shade Fits XT1 LT42 E # 490-900-0067

PRO Z 100 S SERIES

SELECTION GUIDE	PRO Z 148 S	PRO Z 154 S
ENGINE		
Engine Type	25HP Kohler® Confidant V-Twin OHV EFI EZT-735	27HP Kohler® Confidant V-Twin OHV EFI EZT-745
Fuel Tank Capacity	Twin 13 litre fuel tanks - 26 litres total to keep you mowing longer	
DRIVE SYSTEM		
Transmission	Commercial-grade Dual Hydro-Gear® Transmissions with charge pumps that work at the same time to give you more power, stability and manoeuvrability for an easier cut	
CONTROLS		
Steering Control	Four-wheel steering with steering wheel control	
Mow In Reverse	Standard	
CUTTING DECK		
Deck Construction	Floating, fabricated 10 ga (0.135") steel shell (e-coated)	
Cutting Width	122cm (48")	137cm (54")
Height Adjustment	15-position / 2.5cm - 12.7cm (1" - 5")	
Deck Blade Engagement	Electric Warner® clutch - 125 Ft Lb	
CHASSIS		
Frame	Fully-welded, full length 12-gauge channel frame with 14-gauge reinforcements	
Front / Rear Tyres	13.00 x 6.50 (smooth) / 23.00 x 10.50 (turf)	
ROPS	Foldable, 3-position Roll Over Protection System designed to keep you safe when mowing on difficult terrain	
COMFORT		
Seat	High-back EVC comfort seat with armrests, dial suspension, seat belt and 15cm (6") of seat travel	
ADDITIONAL FEATURES		
Additional Features	Rear hitch standard	
WARRANTY		
Warranty	Unit: 3-year domestic and 2-year commercial / Engine: 3-year domestic and 3-year commercial. 5-year fabricated deck shell.	

ACCESSORIES

				
Mulch Kit 48" Deck Fits PRO Z 148 S # 19A70037100	Mulch Kit 54" Deck Fits PRO Z 154 S # 19B70038100	Power Assist Double Bagger Catcher Fits PRO Z 148/154 S # 59A30046150	4 Litre 4-Stroke Oil 10W30 # 333-000-0004	20 Litre 4-Stroke Oil 10W30 # 330-000-0010







PRO Z 500 S / 700 S

SELECTION GUIDE	PRO Z 554 S	PRO Z 560 S	PRO Z 760 S
ENGINE			
Engine Type	27HP Kawasaki® FX850v V-Twin OHV, 852cc	31HP Kawasaki® FX921v V-Twin OHV, 999cc	31HP Kawasaki® FX921v V-Twin OHV, 999cc
Fuel Capacity	Twin 28 litre fuel tanks - 56 litres in total to keep you mowing longer		
DRIVE SYSTEM			
Transmission	12cc Parker® HTJ pump with hydro release lever	14cc Parker® HTG pump with hydro release lever	
CONTROLS			
Steering Control	High performance steering wheel with electronic power steering and foot-pedal control		
Mow In Reverse	Standard		
CUTTING DECK			
Deck Construction	Floating, fabricated 7-gauge top plate, 7-gauge bottom reinforcements, 1/4" rolled leading edge		
Cutting Width	137cm (54"), fabricated steel	152cm (60"), fabricated steel	
Height Adjustment	16-positions / 2.5cm - 12.7cm (1" - 5")		
Deck Blade Engagement	Warner PTO clutch (125 ft-lb)		Warner PTO clutch (200 ft-lb)
CHASSIS			
Frame	Fully-welded, full-length 3/8 x 5" laser cut steel / integrated tie-down slots		
Front / Rear Tyres	15.00 x 6.00 (turf) / 24.00 x 12.00 (turf)		16.00 x 6.50 (turf) / 24.00 x 12.00 (turf)
ROPS	Foldable, 3-position Roll Over Protection System designed to keep you safe when mowing on difficult terrain		
COMFORT			
Seat	High-back dial suspension with EVC cushion, seat belt, angle-back adjust and armrests	High-back dial suspension with EVC cushion, adjustable angle back and padded arm rests, lumbar adjustment and ISO mounts	
ADDITIONAL FEATURES			
Additional Features	Rear hitch standard		
WARRANTY			
Warranty	Unit: 3-year domestic and 3-year commercial / Engine: 3-year domestic and 3-year commercial. 5-year fabricated deck shell.		

ACCESSORIES				
				
Mulch Kit 54" Deck Fits PRO Z 554 S # 19B70038100	Mulch Kit 60" Deck Fits PRO Z 560/760 S # 19A70039100	Power Assist Triple Bagger Catcher Fits PRO Z 554 S/560 S & PRO Z 760 S # 59A30047150	4 Litre 4-Stroke Oil 10W30 # 333-000-0004	20 Litre 4-Stroke Oil 10W30 # 330-000-0010

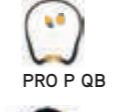
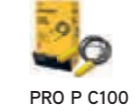
PRO Z 900 S / SD / SDL

SELECTION GUIDE	PRO Z 972 S	PRO Z 972 SD	PRO Z 972 SDL
ENGINE			
Engine Type	35HP Kawasaki® FX1000 V-Twin OHV, 999cc		
Fuel Capacity	Twin 28 litre fuel tanks - 56 litres in total to keep you mowing longer		
DRIVE SYSTEM			
Transmission	Parker 16cc pumps and 310cc wheel motors		
CONTROLS			
Steering Control	High performance steering wheel with electronic power steering and foot-pedal control		
Mow In Reverse	Standard		
CUTTING DECK			
Deck Construction	Floating, fabricated 7-gauge top plate, 7-gauge bottom reinforcements, 1/4" rolled leading edge		
Cutting Width	183cm (72")		
Height Adjustment	16-position / 2.5cm - 12.7cm (1" - 5") foot pedal with spring assist	16-position / 2.5cm - 12.7cm (1" - 5") with electronic power deck lift system	
Deck Blade Engagement	Electric Warner® PTO clutch - 225 Ft Lb with Soft-Start		
CHASSIS			
Frame	Fully-welded, full-length 3/8 x 5" laser cut steel / integrated tie-down slots		
Front / Rear Tyres	16.00 x 6.50 (turf) / 26.00 x 12.00	16.00 x 6.50 / Dual TERRA TRAC tread 25.00 x 9.00 (18" TRAC width)	
ROPS	Foldable, 3-position Roll Over Protection System designed to keep you safe when mowing on difficult terrain		
COMFORT			
Seat	High-back, quick adjust Air Ride suspension with EVC cushion, adjustable angle back and padded arm rests, lumbar adjustment and ISO mounts	High-back, swivel platform quick adjust Air Ride suspension with EVC cushion, adjustable angle back and padded arm rests, lumbar adjustment and ISO mounts	
ADDITIONAL FEATURES			
Additional Features	Rear hitch standard		
WARRANTY			
Warranty	Unit: 3-year domestic and 3-year commercial / Engine: 3-year domestic and 3-year commercial. 5-year fabricated deck shell.		

ACCESSORIES							PPE			
										
Mulch Kit 72" Deck Fits PRO Z 972 S/SD/SDL # 59A30053150	4 Litre 4-Stroke Oil 10W30 # 333-000-0004	20 Litre 4-Stroke Oil 10W30 # 330-000-0010	PRO P QB Earplugs / Earmuffs	PRO P C100 PRO P UT Earplugs / Earmuffs	PRO P H Straw Sun Hat	PRO P C5 PRO PR Premium Gloves	PRO PS PRO PC PRO PSP Safety Glasses			



YOUR AUTHORISED CUB CADET DEALER MAKES YOUR EXPERIENCE EVEN BETTER.

Cub Cadet dealers know their equipment. And they know how to take care of it and their customers. You'll get exceptional financing, great offers and the expertise you can only find from professionals who sell and service Cub Cadet equipment every day.

Strongest support in the industry: Visit www.cubcadet.com.au or call 1300 951 594.

 facebook.com/cubcadetaus

 [@cubcadetaus](https://instagram.com/cubcadetaus)

 www.youtube.com/cubcadetaustralia

For more information, please call **1300 951 594** or visit www.cubcadet.com.au

Not all products available at all dealers. A failure by a supplier to deliver in accordance with sample description or not at all or other unintentional causes may result in some products being unavailable. Product availability, images and specifications may change without prior notice. Images may not reflect dealer inventory or unit specifications. Engine descriptions, warranty and horsepower (HP) are by the engine manufacturer.

*For more information on our warranty, please contact your local Cub Cadet Dealer. FEB23

2023 Cub Cadet | PART# CUBCAT2023